

**CONTROL BY A TRIAC FOR AN INDUCTIVE LOAD
HOW TO SELECT A SUITABLE CIRCUIT**

By X. DURBECQ

Today triacs are well suited to the requirements of switching inductive loads.

Nevertheless many users still encounter difficulties when designing triac control circuits which are to be both economical and applicable to inductive loads.

The purpose of this article is to present different methods of triac control with their applications and to analyze their relative advantages and disadvantages.

A simple circuit offering all the guarantees of reliability is proposed for industrial loads.

TRIGGERING WITH SYNCHRONIZATION ACROSS THE TRIAC

The triggering circuit with "synchronization across the triac" (fig. 1 and 2) turns on the component at an angle β after the current drops to zero, such that $\beta = \omega \cdot T_r$.

Time T_r is defined by the time constant $(P + R_t)C$.

$\omega = 2 \cdot \pi \cdot f$ with $f =$ mains frequency.

Figure 1 : Typical Circuit : Synchronization Across the Triac.

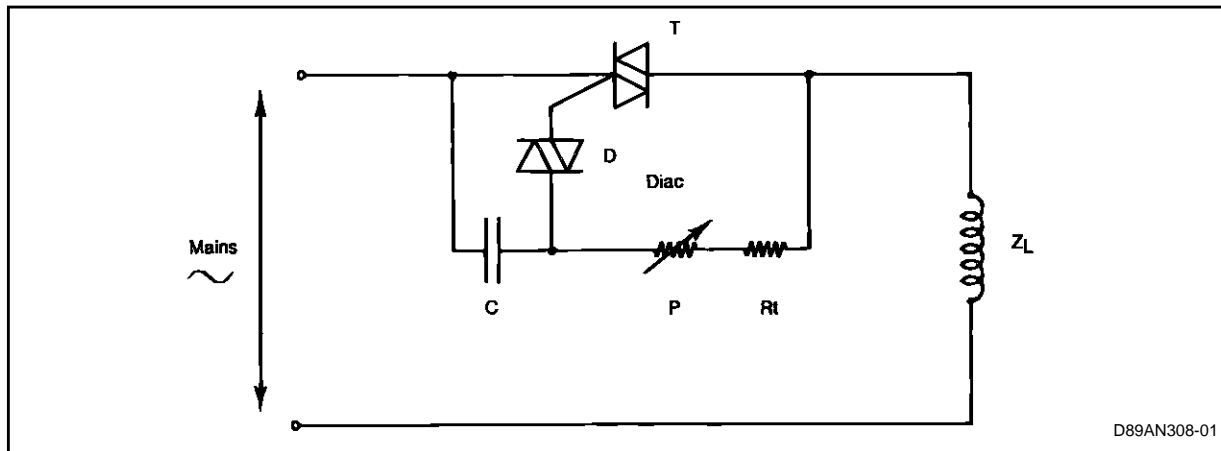

D89AN308-01

Figure 2 : Synchronization Across the Triac. Shape of the Signals ; General Case.

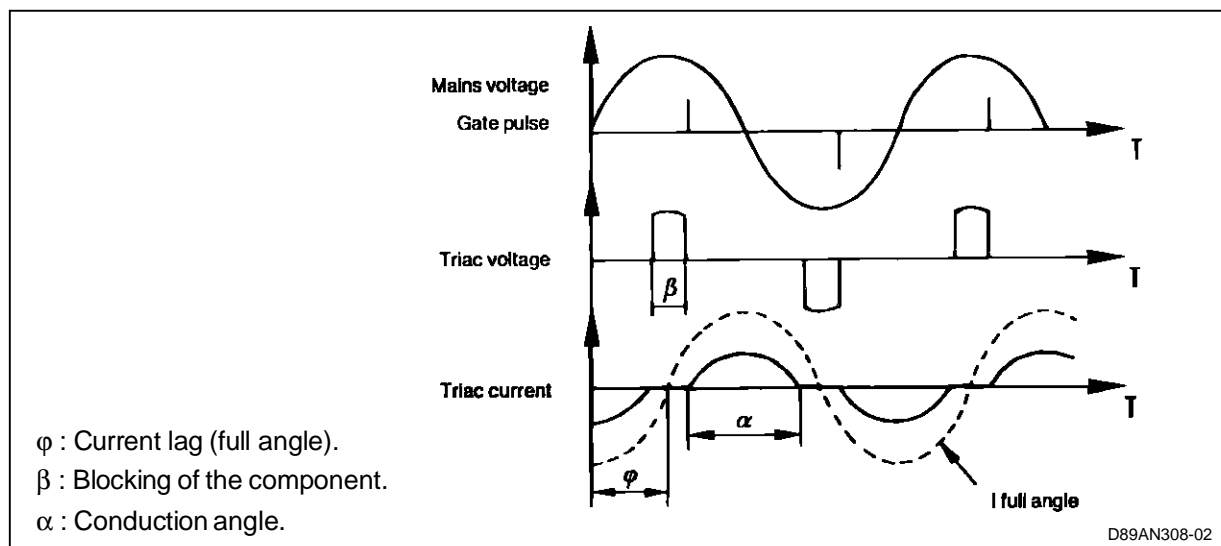

D89AN308-02

APPLICATION NOTE

This is the simplest possible circuit but in certain cases of utilization it can have an important drawback.

For example, consider a highly inductive load ($L\omega / R > 4$) where the triac is turned on with a considerable delay $\beta = 100^\circ$ after the mains voltage zero (figure 3).

The duration of conduction α of the triac turned on at point A, is about 150° . The triac is blocked at point B at $\alpha + \beta = 250^\circ$ after the zero voltage point. At that instant a negative voltage is applied to the triggering circuit which turn on the triac at point C after an angle β of 100° , i.e. 350° from the starting point. The second turn-on will occur at a very low voltage

and the angle α' will be much smaller than α . The following period begins under similar conditions and the unbalance persists. This type of asymmetrical operation is not only unacceptable but can be dangerous (saturation of the load by a DC component).

The unbalance is illustrated for a particular case, starting from zero of the mains voltage. Other causes also produce this fault : variation of the load impedance, transient operation, modification of the adjustment... The reason for this is the principle of the circuit which does not take its reference from the mains voltage zero. Synchronization is by the voltage across the triac, which is a function of the current in the load.

Figure 3 : Synchronization Across the Triac. Shape of the Signals.

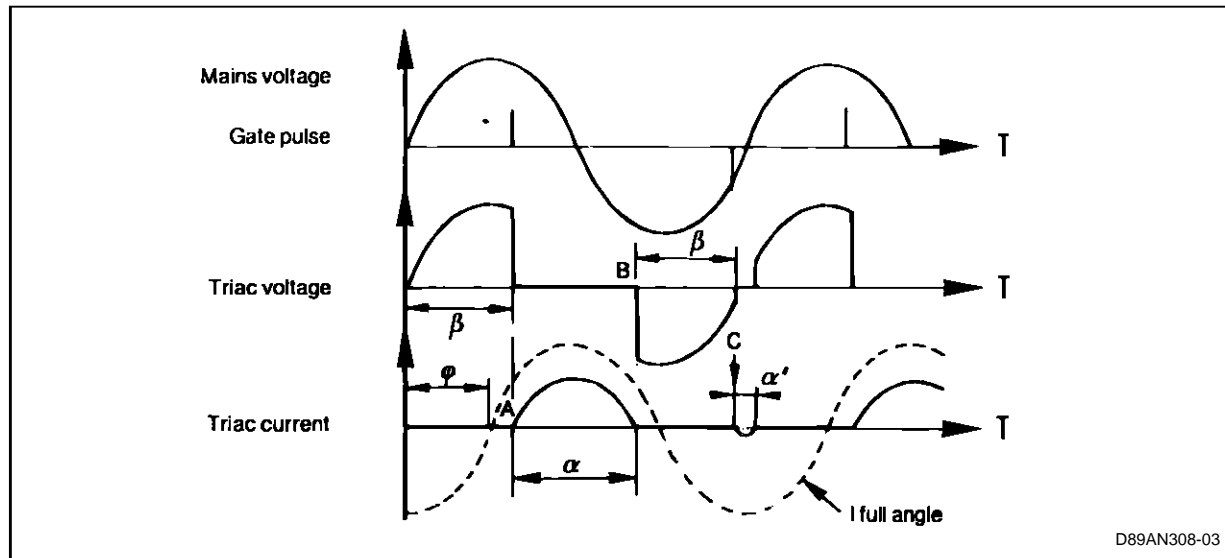

Summing up, this first very simple triggering circuit, synchronized by the voltage across the triac, has :

1) Definite advantages :

- Simple design and low cost.
- **Connection by two wires**, without polarity.
- Absence of a separate power supply.
- Little power dissipated in P and Rt.

2) A serious disadvantage :

Because of its principle, this circuit cannot be used for highly inductive loads with a narrow conduction

angle because it can result in unacceptable asymmetrical operation.

This very simple triggering circuit should be reserved for low-cost applications with the following characteristics :

- Resistive or slightly inductive loads.
- No stringent requirements concerning the accuracy of regulation.
- Variation on highly inductive loads between 85 and 100 % of the maximum power.

TRIGGERING WITH SYNCHRONIZATION BY THE MAINS VOLTAGE

This triggering circuit (figure 4) is synchronized by

the mains voltage. The pulses are always shifted by 180° with respect to each other, whatever the type of load.

Figure 4 : Typical Circuit - Synchronization by Mains Voltage.

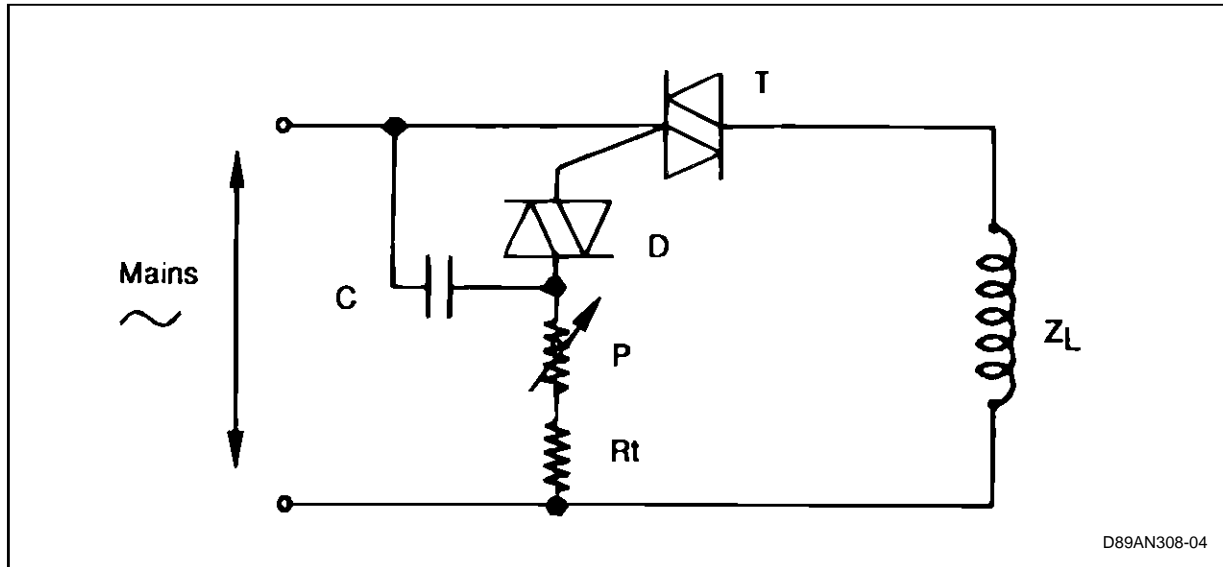
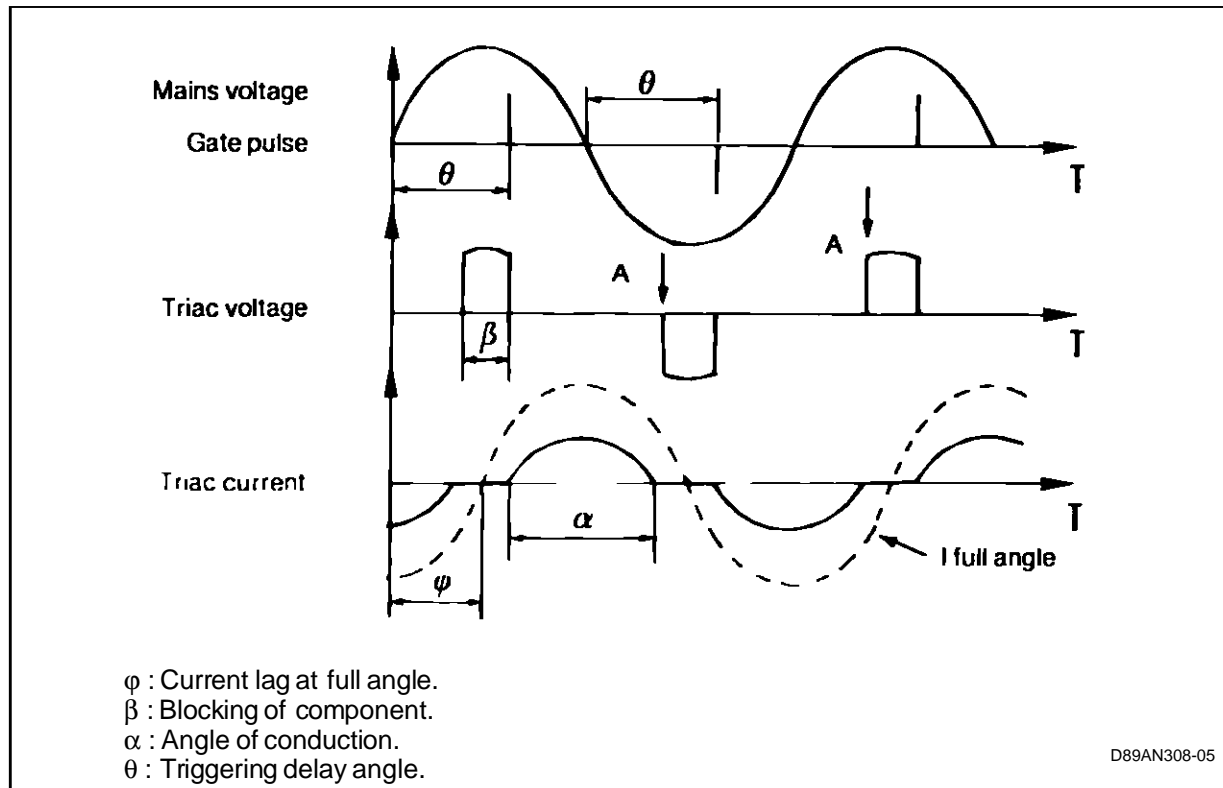

Figure 5 : Synchronization by the Mains Voltage : Shape of Signals.



Angle θ , characterizing the delay between the mains voltage zero and the triggering pulse, can be adjusted by means of potentiometer P from 0 to 180° to vary the voltage across the load. The current in an inductive load (L,R) lags with respect to the voltage by an angle φ :

$$(\tan \varphi = L \cdot \omega / R).$$

For triggering angles θ higher than φ , operation is perfectly symmetrical and stable.

This simple circuit can still present the risk of a fault in case angle θ is smaller than angle φ (figure 6).

As an example, take the case of a highly inductive load and an angle $\theta = 60^\circ$. The triac is turned on at point A (60°).

It will conduct during an angle α greater than 180°, in the neighbourhood of 250°. It is blocked at point B : (290°). The second triggering pulse occurs at point C : ($\theta + \alpha = 240^\circ$).

It has no action on the triac which is still conducting. The triac is not turned on for the other half-wave. As in the previous case, the operation is asymmetrical, and thus unacceptable.

Figure 6 : Synchronization by the Mains Voltage - Shape of the Signals for $\theta < \varphi$ - Asymmetrical Operation.

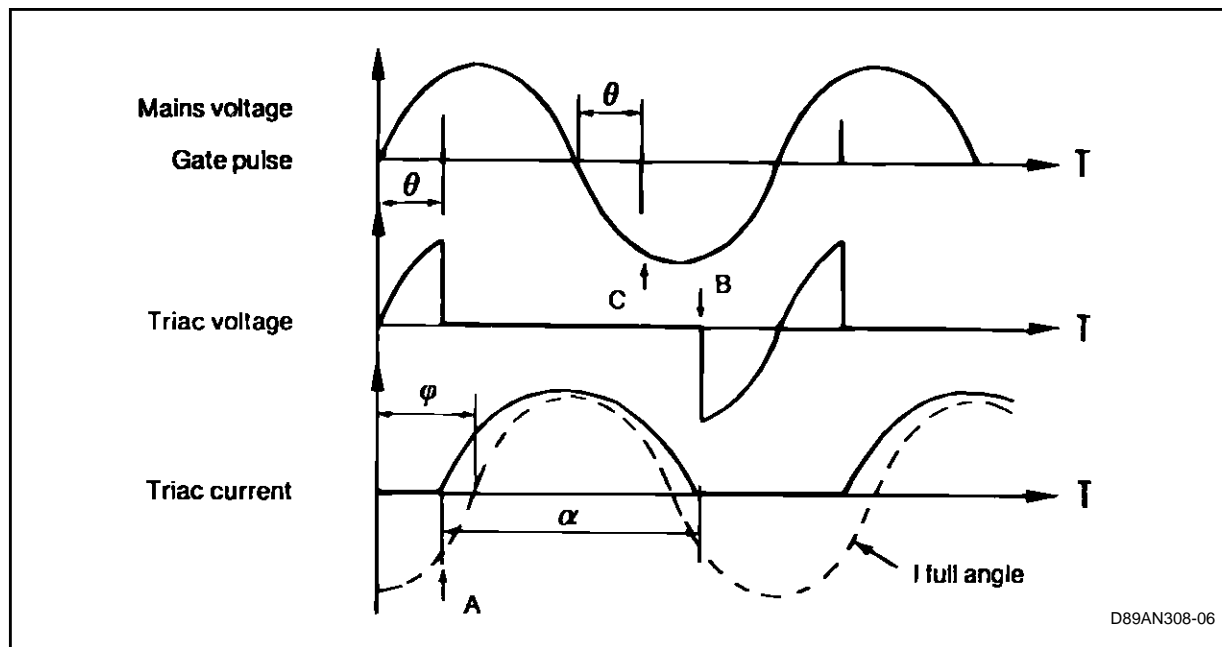

To prevent this fault, it is necessary to insert a "stop" to maintain $\theta > \varphi$. This is possible for loads whose L and R parameters remain strictly constant.

Experience shows that for the majority of inductive loads used in industrial applications (motor controls, transformers, etc...) it is not possible to insert the "stop" without considerably limiting the voltage excursion, since the values of L and R vary a great deal during operation.

Summing up, this simple triggering circuit, synchronized by the mains voltage, is more developed than the previous one. It has :

1) Advantages:

- Simple design.

- More accurate control than the previous circuit.
- No auxiliary power supply or transformer required.

2) Disadvantages:

- Connection of the circuit by 3 marked wires, instead of 2 without polarity in the previous circuits.
- Power dissipated in passive components P and Rt.
- Operation becomes completely asymmetrical if the control angle θ is less than φ .

This triggering circuit can only be used for applications in which the phase shift of the load remains constant (air inductor) or if operation is restricted to values of θ much higher than φ i.e. at low voltage.

TRIGGERING SYNCHRONIZED BY THE MAINS VOLTAGE AND SUITABLE FOR INDUSTRIAL APPLICATIONS

This new circuit is derived from the previous one by improving the triggering pulse generator. The improve-

ment consists in maintaining the triggering signal during each half-wave between values θ and 180° . This is done simply by sending a pulse train after the initial pulse so as to maintain the triggering order (figure 7).

Figure 7 : New Circuit - Triggering by Pulse Train Synchronization by the Mains Voltage.

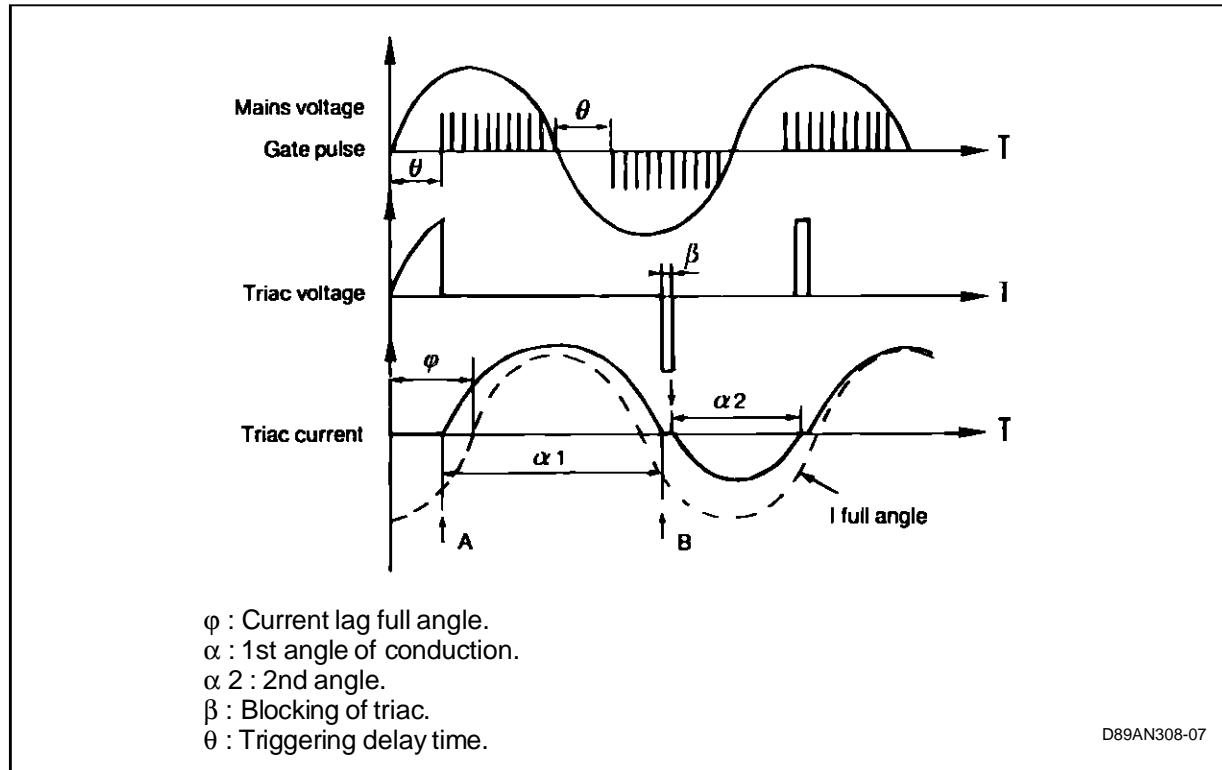

For example, suppose that angle ϕ is equal to 85° and θ is equal to 60° . At the first pulse, the triac is turned on at point A (60°). It conducts for angle $\alpha 1$ greater than 180° and close to 240° . It is blocked at point B but is immediately triggered at point B' by the

next repetitive pulse. During the first half-waves, operation is slightly asymmetrical but gradually the durations of conduction become balanced (dotted line curve in figure 7).

Figure 8 : Circuit with Triggering by Pulse Train Synchronization by Mains Voltage.

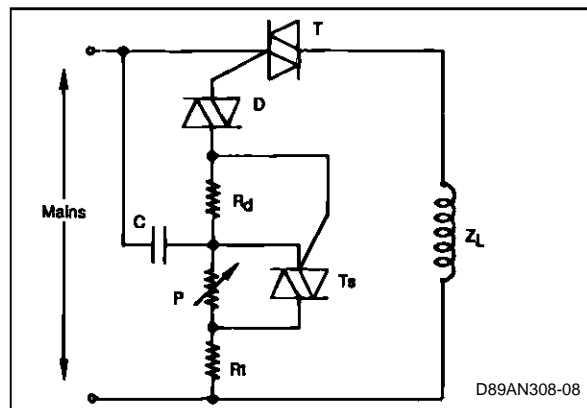

Figure 8 gives the circuit diagram. A small sensitive auxiliary triac is used to produce the pulse train necessary for maintaining the control signal.

Capacitor C, compensating resistor R_t and potentiometer P define the angle θ or delay time constant. The capacitor is charged from 0 V and diac D triggers as soon as its breakover voltage (V_{bo}) is reached. The angle is positioned identically for both half-waves.

A first pulse is applied to the gate of the main triac, T. A voltage pulse occurs across R_d and triggers sensitive triac T_s . Once it has been turned on, this triac bypasses potentiometer P. The remaining charging cycles of the capacitor have a much shorter time constant $R_t \times C$.

A succession or train of pulses is applied to the gate of the main triac, T, enabling elimination of the defects explained above. The pulse train continues until the mains voltage crosses the O point. Triac Ts, supplied through a resistive load, is blocked.

For the following half-cycle, the capacitor load is once more based on the time constant determined by the potentiometer. The cycle is resumed in inverse.

Summing up, the improved triggering circuit synchronized by the mains voltage has a number of advantages.

CONCLUSION :

The difficult conditions of an inductive environment require a critical choice of the triggering circuit. The first two circuits described leave the user a very limited adjusting range. A universal circuit can be obtained by taking into account two decisive factors :

- To obtain perfect symmetry of the first gate pulses in both half-cycles, the triggering circuit should be synchronized by the mains voltage.

- Simplicity of design.
- Excellent accuracy of control.
- Absence of auxilliary separate power supply.
- Utilization of the circuit for all types of loads with different $\cos \varphi$ or variable $\cos \varphi$ values.
- No risk of failure over the whole adjusting range.

This circuit has been developed by the SGS-THOMSON Microelectronics applications laboratory and used with success for a wide range of equipment.

- The variation in phase angle enables perfect symmetry of the current if the triac is continuously triggered.

The circuit described in the last paragraph combines these two principles in a very simple manner. It enables complete variation of power on an inductive load without particular problems. It can thus serve as the basis for a universal circuit for control by phase splitting on a inductive load.

SYNCHRONIZATION ACROSS THE TRIAC

Figure 9 : Example of an Application : Speed-control Circuit for a Small Asynchronous Motor.

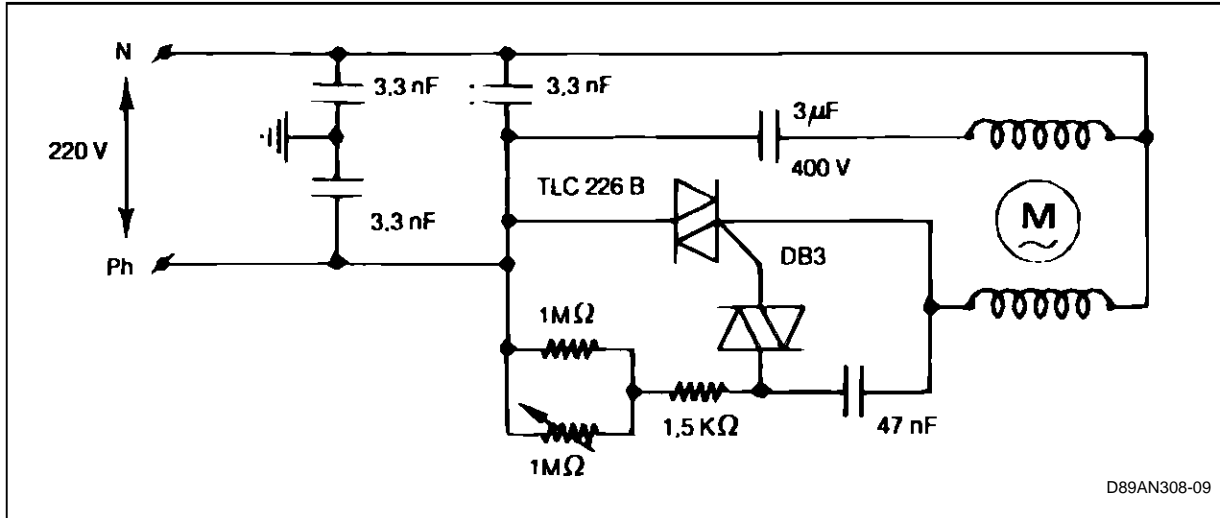

SYNCHRONIZATION BY THE MAINS VOLTAGE

Figure 10 : Example of an Application : 220/110 V Step-down Circuit.

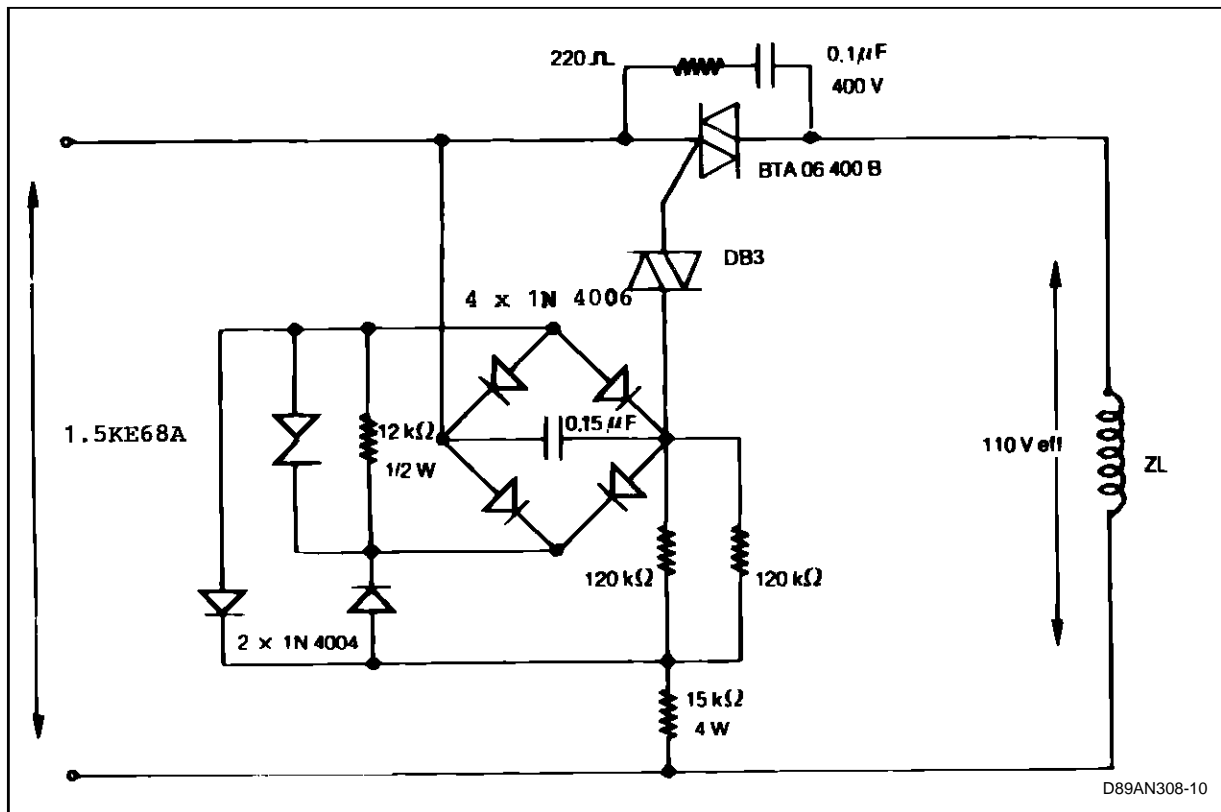

NEW TRIGGERING CIRCUIT

Figure 11 : Example of an Application : Power Variation Circuit for Arc Welding Transformer.

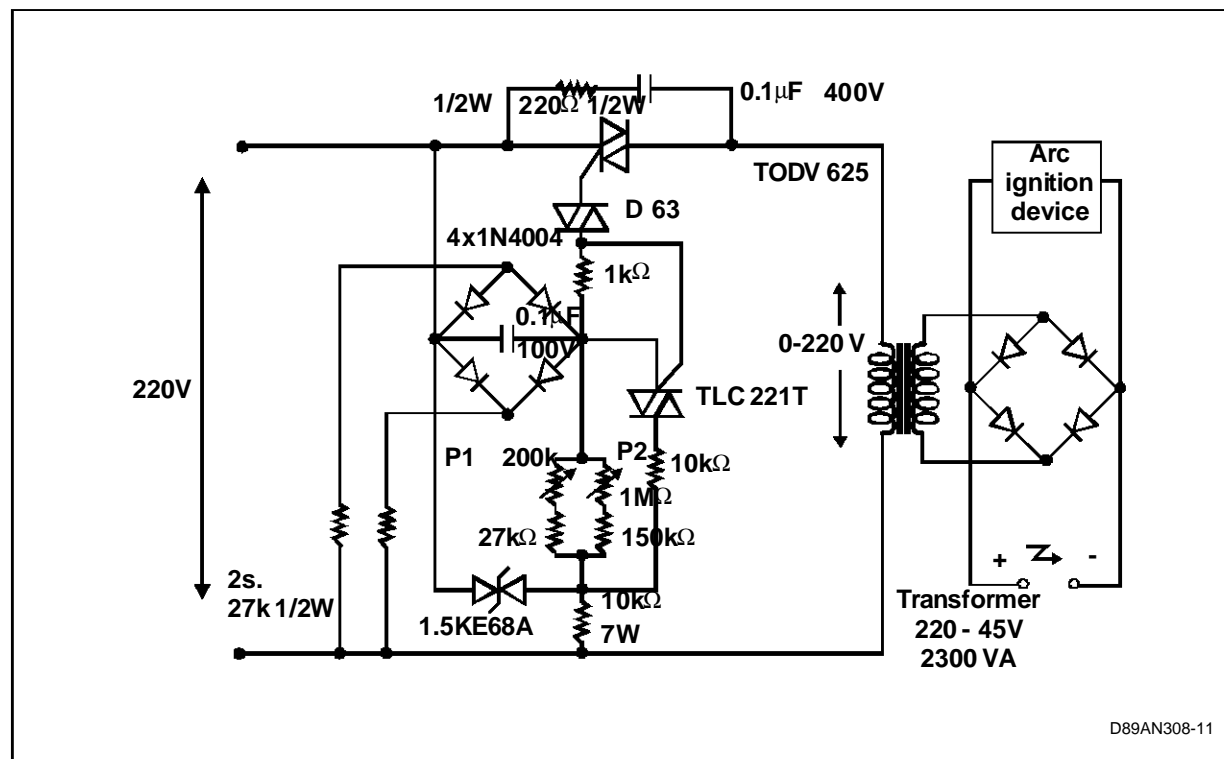

D89AN308-11

APPENDIX CONTROL BY TRIAC FOR INDUCTIVE LOADS SUMMARY OF SOLUTIONS

A SYNCHRONOUS TRIGGERING ACROSS THE TRIAC

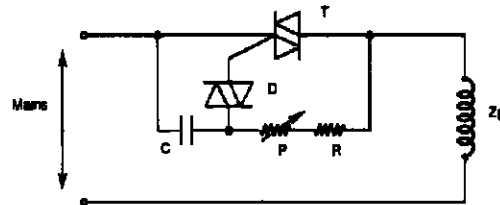

Synchronization across the triac based on crossing of the zero point by the current.

B TRIGGERING SYNCHRONIZED BY THE MAINS VOLTAGE

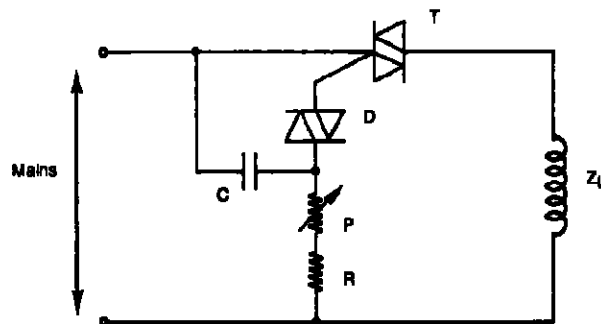

Synchronization based on crossing of the zero point by the mains voltage

C NEW TRIGGERING CIRCUIT

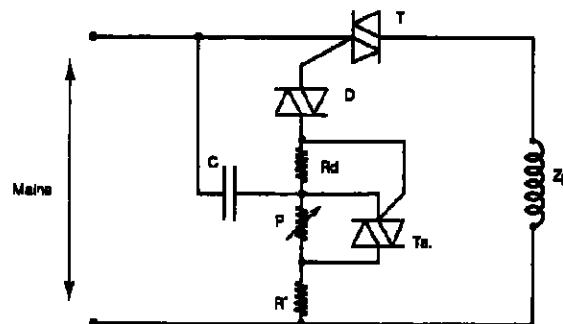

Synchronization by crossing of the zero point by the mains voltage and generation of a pulse train from then onwards.

D89AN308-14

TRIGGERING SYNCHRONIZED ACROSS THE TRIAC

SCHEMATIC DIAGRAM (see page 10-A)

RESISTIVE LOAD :

Current and voltage are in phase : good synchronization. No fault over the whole adjusting range.

INDUCTIVE LOAD :

The current lags by $\pi / 2$. Two cases should be considered :

- Broad conducting angle ; narrow lag angle.

The time separating two conducting periods is very brief. The positive and negative currents are practically equivalent. Little dissymmetry. Certain applications are covered by this case.

e.g. speed-control circuit for AC motors.

- Narrow conducting angle ; broad lag angle.

The flow of current in one direction is a function of the control and thus of the duration of the current flow in the previous direction.

The triac can be triggered at the end of the mains half-cycle. In this case no current flows through the circuit and it acts as a rectifier.

ADVANTAGES OF THE CIRCUIT :

- Connection by two wires without polarity.
- No power dissipated by the passive components.
- Excellent power variation circuit for resistive or slightly inductive loads.
- With highly inductive loads, the circuit can only give satisfaction within the limits of a slight decrease in the conducting angle.

DISADVANTAGES :

- For inductive loads, large current dissymmetry for a variation towards the narrowest conduction angles. For this type of application the circuit cannot be used at all.

TRIGGERING SYNCHRONIZED BY THE MAINS VOLTAGE

SCHEMATIC DIAGRAM (see page 10-B)

RESISTIVE LOAD :

No fault over the whole adjusting range.

INDUCTIVE LOAD :

Two cases should be considered :

- Delay angle $\theta >$ the lag, φ .

Correct synchronization of the triggering pulses enables balanced conduction for all variations up to the lag angle.

Certain applications use this principle :

e.g. 200 V – 100 Vrms step-down circuit.

- Delay angle $\theta <$ φ .

Triggering occurs before the lag angle is reached. The triac will conduct for an angle $\alpha > 180^\circ$. It is blocked after the gate pulse of the following half-cycle. The current does not flow in that direction. The circuit thus acts as a rectifier.

ADVANTAGES OF THE CIRCUIT

- Accuracy of the triggering pulses.
- Current operation with a resistive load but circuit too complex.
- Excellent operation for power variation circuits limiting conduction to small angles with inductive loads.

DISADVANTAGES :

- Connection by three wires. Necessity to obtain access to the mains terminals.
- Permanent power supply with power dissipated by the passive components.
- Impossible to adjust the delay angle to values approaching or inferior to the current lag. This circuit cannot be used for inductive loads where a variation close to the highest conduction angles is required.

NEW TRIGGERING CIRCUIT

SCHEMATIC DIAGRAM (see page 10-C)

RESISTIVE LOAD :

Absence of fault over the whole adjusting range.

INDUCTIVE LOAD :

Operation in the two possible cases :

- Delay angle $\theta >$ φ

Balanced conduction due to perfect synchronization of the triggering pulses.

- Delay angle $\theta <$ φ

For a conduction angle higher than 180° , the triac is blocked after the 1st pulse of the following half-cycle. It is immediately retriggered by the next repetitive pulse. The two currents are mutually modified until a balance is reached.

DISADVANTAGES OF THE CIRCUIT :

- Connection by 3 wires. Access to the mains terminals.
- Permanent power supply with power dissipated in the passive components.

ADVANTAGES :

- Accuracy of the triggering pulses.
- Correct operation for resistive loads.
- Complete absence of faults for inductive loads.

Power variation over the whole range.
Perfectly balanced positive and negative current.

Information furnished is believed to be accurate and reliable. However, SGS-THOMSON Microelectronics assumes no responsibility for the consequences of use of such information nor for any infringement of patents or other rights of third parties which may result from its use. No license is granted by implication or otherwise under any patent or patent rights of SGS-THOMSON Microelectronics. Specifications mentioned in this publication are subject to change without notice. This publication supersedes and replaces all information previously supplied.

SGS-THOMSON Microelectronics products are not authorized for use as critical components in life support devices or systems without express written approval of SGS-THOMSON Microelectronics.

© 1995 SGS-THOMSON Microelectronics - Printed in Italy - All rights reserved.

SGS-THOMSON Microelectronics GROUP OF COMPANIES

Australia - Brazil - France - Germany - Hong Kong - Italy - Japan - Korea - Malaysia - Malta - Morocco -
The Netherlands - Singapore - Spain - Sweden - Switzerland - Taiwan - Thailand - United Kingdom - U.S.A.